

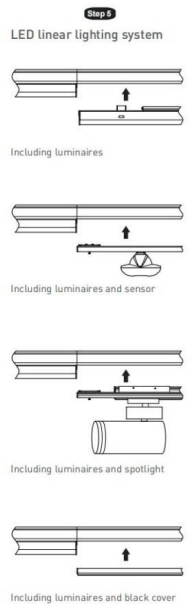

Tracking and luminaire:

First trunking rail should have one side connecting plate&last trunking rail with no connecting plate on both sides, then fix the Luminaire to trunking rail then lock holder, then keep end caps at both sides.

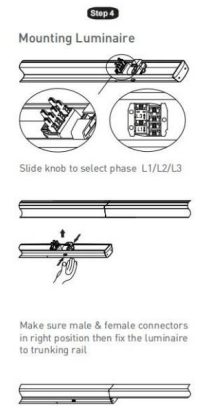
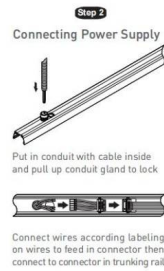

Wire diagram of triple circuits function

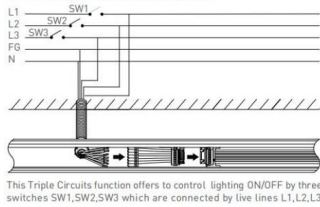

Pendant and mounting installation

Starting Installation distances point should be 800 mm to 1000 mm, then in between 1st & 2nd point should be 3000 mm max

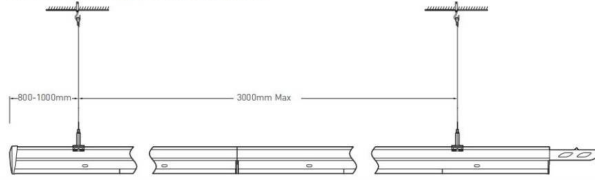

Four options for installation



Safety notes:
Installation should be performed only by qualified electrician.

- Make sure no voltage while installation.
- Connect cable wires according to wire labeling.
- Max current should not exceed 16A in one power feed in circuit.

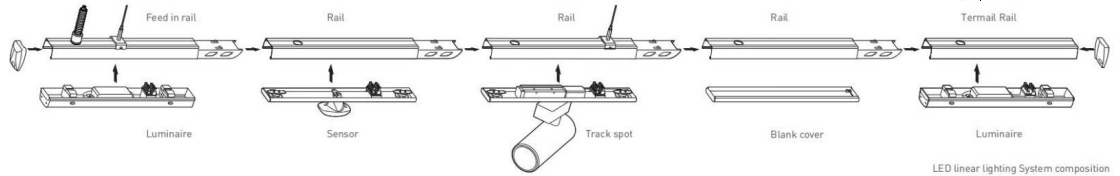

LED linear lighting System composition

Terminal module:

Terminal module can be independently installed as a single unit, it also can be connected at end of one linear light row.

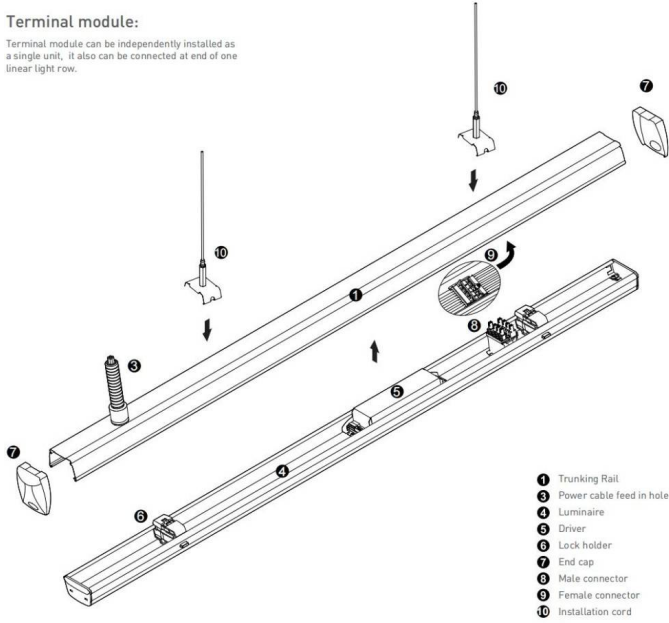

Step 1
Mounting Suspension

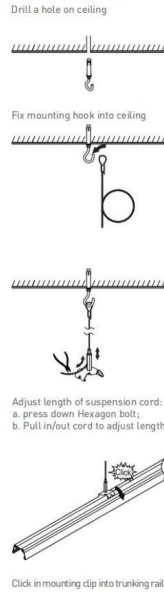

Step 2
Connecting Power Supply



Step 3
Mounting Luminaire

