

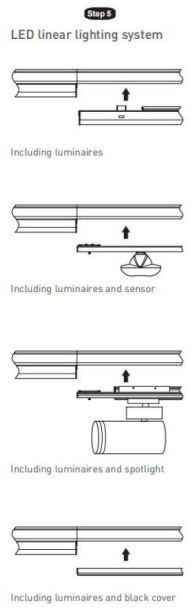

**Tracking and luminaire:**

First trunking rail should have one side connecting plate&last trunking rail with no connecting plate on both sides, then fix the Luminaire to trunking rail then lock holder, then keep end caps at both sides.

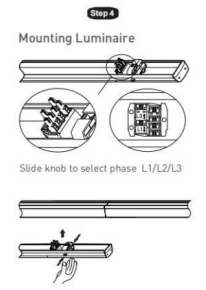
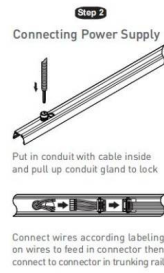
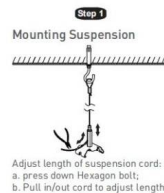
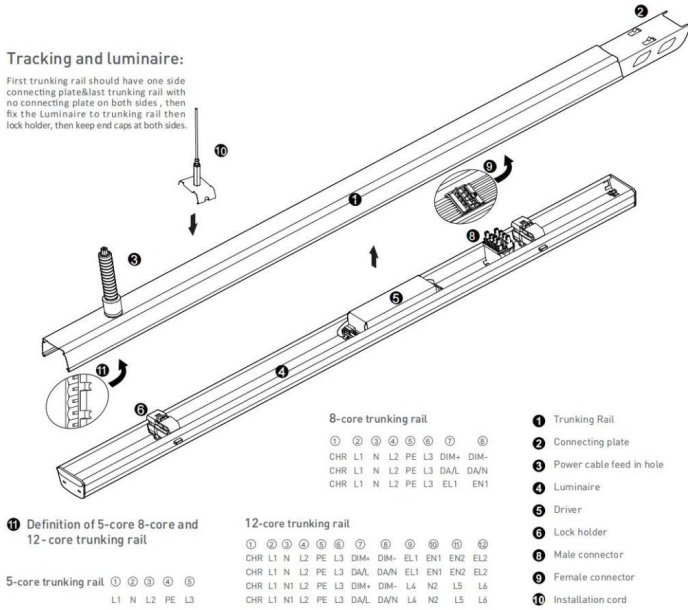

**Wire diagram of triple circuits function**

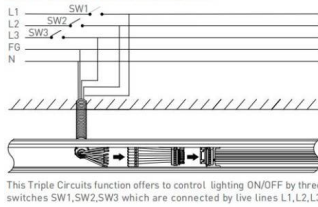

**Pendant and mounting installation**

Starting Installation distances point should be 800 mm to 1000 mm, then in between 1st & 2nd point should be 3000 mm max

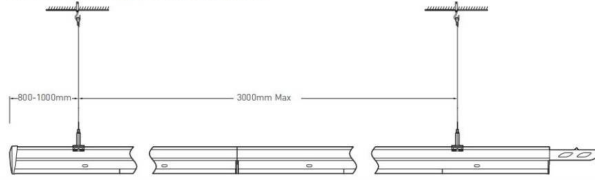

**Four options for installation**



Safety notes:  
Installation should be performed only by qualified electrician.

- Make sure no voltage while installation.
- Connect cable wires according to wire labeling.
- Max current should not exceed 16A in one power feed in circuit.

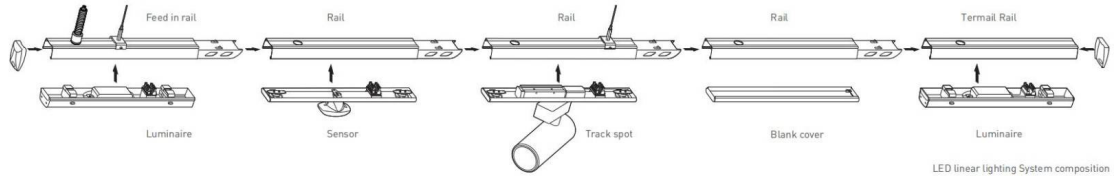

**Terminal module:**

Terminal module can be independently installed as a single unit, it also can be connected at end of one linear light row.

