



SLOT-RM







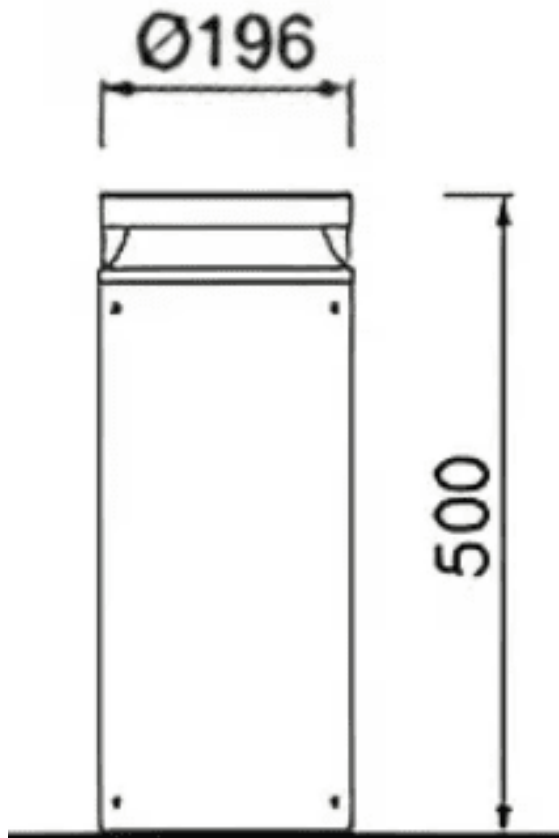

Balise Lavov SLOT-RM, 12 W, angle de faisceau de 360°. Finition noire. Dimensions : \varnothing 118 x H 500 mm. Flux lumineux total : 1 080 lm, efficacité lumineuse : 90 lm/W. Température de couleur : 3 000 K. Circuit intégré marche/arrêt. Corps en aluminium moulé sous pression, mât en aluminium extrudé et diffuseur en polycarbonate. Indice de protection : IP66, IK09.

Dimensions

Product dimensions (mm) \varnothing 118xH500mm

Dessin technique



Code article	86.OB22.2301.02
Type de produit	
Catégorie	Balises
Famille	SLOT-RM
Pictograms	       

Produit	
Puissance système (W)	12
Flux lumineux utile (lm)	1080
Efficacité lumineuse (lm/W)	90
Angle de faisceau	360
Durée de vie	50000h L80B10
IP	IP66
Finition	Noir
Driver intégré	oui
Équipement	ON-OFF
Source lumineuse	LED
Type de LED	SMD
Température de couleur (K)	3000
Uniformité chromatique (SDCM)	SDCM3
CRI	90
IK	IK09