



### SLOT-RM

Balise Lavov SLOT-RM, 9 W, angle de faisceau de 180°. Finition noire. Dimensions :  $\varnothing$  118 x H 300 mm. Flux lumineux total : 1 080 lm, efficacité lumineuse : 90 lm/W. Température de couleur : 3 000 K. Circuit intégré marche/arrêt. Corps en aluminium moulé sous pression, mât en aluminium extrudé et diffuseur en polycarbonate. Indice de protection : IP66, IK09.

#### Dimensions

Product dimensions (mm)  $\varnothing$ 118xH300mm

#### Dessin technique

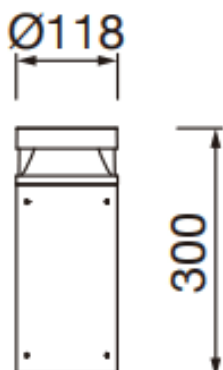
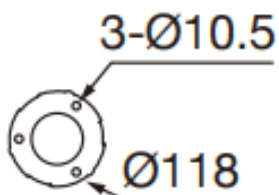

Code article	86.OB23.1301.02
Type de produit	Extérieur
Catégorie	Balises
Famille	SLOT-RM
Pictograms	 

Produit	
Puissance système (W)	9
Flux lumineux utile (lm)	1080
Efficacité lumineuse (lm/W)	90
Angle de faisceau	180
Durée de vie	50000h L80B10
IP	IP66
Finition	Noir
Driver intégré	oui
Équipement	ON-OFF
Source lumineuse	LED
Type de LED	SMD
Température de couleur (K)	3000
Uniformité chromatique (SDCM)	SDCM3
CRI	90
IK	IK09