



SAFE

Projecteur extérieur Lavov SAFE de 50 W avec un angle de faisceau de 25°. Flux lumineux total de 7 250 lm et efficacité lumineuse de 145 lm/W. Fabriqué en aluminium moulé sous pression à faible teneur en cuivre, il est idéal pour les environnements corrosifs. Finition peinture poudre noire. Indices de protection IP66 et IK08. Driver ON-OFF.

Dimensions

Product dimensions (mm) **353x287x65mm**

Dessin technique

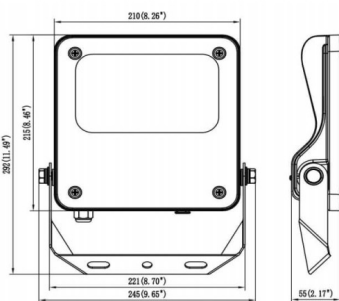

50W

Code article	86.OF03.1421.02
Type de produit	Extérieurs
Catégorie	Industriel
Famille	SAFE
Pictograms	

Produit	
Puissance système (W)	50
Flux lumineux utile (lm)	7250
Efficacité lumineuse (lm/W)	145
Angle de faisceau	25°
IP	IP66
Température de fonctionnement	-30°C to + 50°C
Finition	noir
Driver intégré	oui
Équipement	ON-OFF
Power Factor	>0,95
Source lumineuse	LED
Type de LED	NF2W757GR-V5
Durée de vie utile (h)	Up to 100,000hrs LM70
Température de couleur (K)	4000K
Uniformité chromatique (SDCM)	5
CRI	70
IK	IK08