



ING-SMINI

Spot encastré au sol Lavov ING-SMINI, luminaire de 1,2 W, angle de faisceau de 60°. Finition inox. Dimensions : 38 x 38 x 65 mm. Flux lumineux total : 110 lm ; efficacité lumineuse : 91,5 lm/W. Température de couleur : 3 000 K. Driver non inclus. Corps en aluminium moulé sous pression, bague frontale en inox et diffuseur en verre trempé. Indice de protection : IP67, IK07.

Dimensions

Product dimensions (mm) 38x38x65mm

Dessin technique

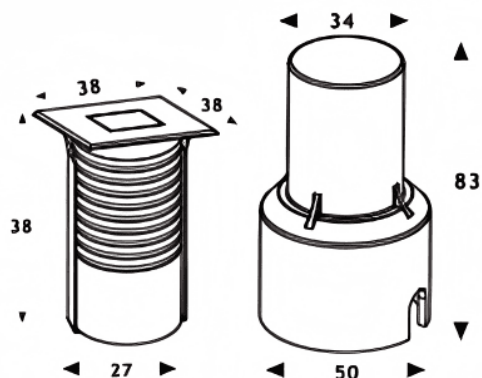

Distribution photométrique

Code article	86.OI18.2331.07			
Type de produit	Extérieurs			
Catégorie	Monté au sol			
Famille	ING-SMINI			
Pictograms				

Produit	
Puissance système (W)	1.2
Flux lumineux utile (lm)	110
Efficacité lumineuse (lm/W)	91.5
Angle de faisceau	60
Durée de vie	50000h L80B10
IP	67
Classe d'isolation	Classe I
Finition	Acier inoxydable
Driver intégré	non
Équipement	Not included
Température de couleur (K)	3000
Uniformité chromatique (SDCM)	SDCM3
CRI	80
IK	IK07

