



ING-MINI







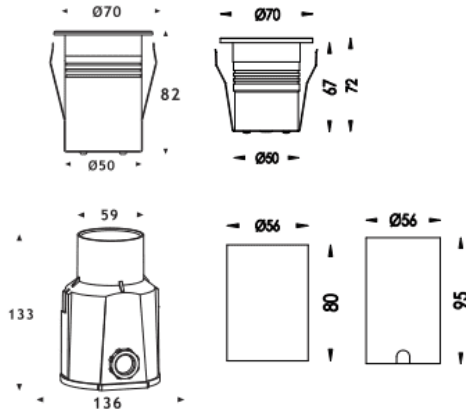

Spot encastré au sol Lavov ING-MINI, 5 W, angle de faisceau de 60°. Finition inox. Dimensions : 70 x 70 x 82 mm. Flux lumineux total : 508 lm ; efficacité lumineuse : 101 lm/W. Température de couleur : 3000 K. Driver ON-OFF. Corps en aluminium moulé sous pression, anneau frontal en inox, diffuseur en verre trempé. Indice de protection : IP67, IK07.

Dimensions

Product dimensions (mm) 70x70x82mm

Dessin technique



Code article	86.OIN1.2341.07
Type de produit	Extérieurs
Catégorie	Monté au sol
Famille	ING
Sous-famille	ING-MINI
Pictograms	       

Produit	
Puissance système (W)	5
Flux lumineux utile (lm)	508
Efficacité lumineuse (lm/W)	101
Angle de faisceau	60
Durée de vie	50000h L80B10
IP	67
Classe d'isolation	Classe III
Finition	Acier inoxydable
Driver intégré	oui
Équipement	ON-OFF
Source lumineuse	LED
Type de LED	1x5W CREE COB
Température de couleur (K)	3000
Uniformité chromatique (SDCM)	SDCM3
CRI	80
IK	IK07