



Spot

Luminaire submersible Lavov Spot de 15 W avec un angle de faisceau de 15°. Indice de protection IP68. Corps en acier inoxydable 316L, façade en verre trempé. Driver non inclus.

Code article	86.OU03.2011.07
Type de produit	Extérieur
Catégorie	Luminaires submersibles
Famille	Spot

Pictograms



Dessin technique

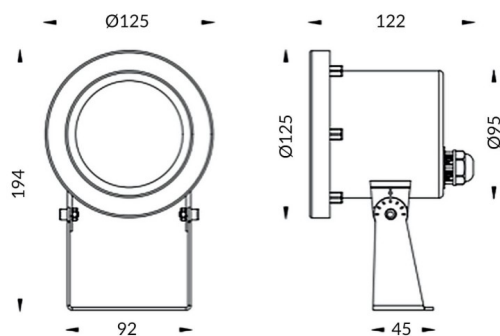

Produit	
Puissance système (W)	15
Flux lumineux utile (lm)	450
Angle de faisceau	15°
IP	68
Finition	Acier inoxydable
Marque de la LED	OSRAM
Driver intégré	non
Équipement	DRIVER EXCL
Durée de vie utile (h)	50000h L80B10
Température de couleur (K)	RGB 3 in 1
CRI	>80
IK	IK08