











Spot

Luminaire submersible Lavov Spot de 15 W avec un angle de faisceau de 60°. Indice de protection IP68. Corps en acier inoxydable 316L, façade en verre trempé. Driver non inclus.

Code article	86.OU03.2031.07
Type de produit	
Catégorie	Luminaires submersibles
Famille	Spot
Pictograms	       

Dessin technique

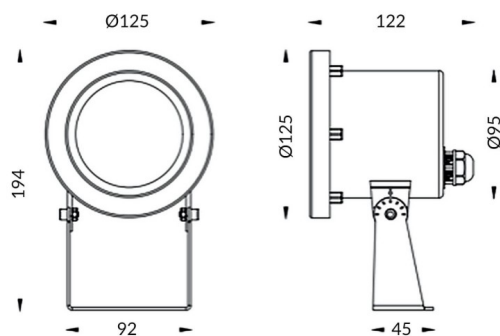

Produit	
Puissance système (W)	15
Flux lumineux utile (lm)	450
Angle de faisceau	60°
IP	68
Finition	Acier inoxydable
Marque de la LED	OSRAM
Driver intégré	non
Durée de vie utile (h)	50000h L80B10
Température de couleur (K)	RGB 3 in 1
CRI	>80
IK	IK05