

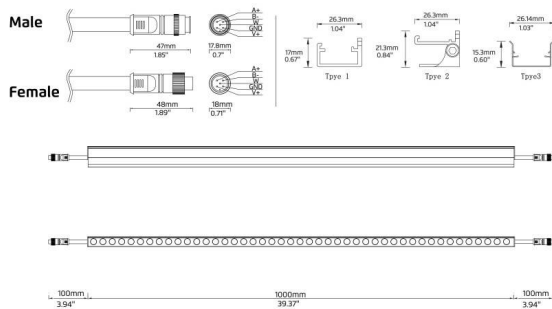

Product Dimensions (mm)

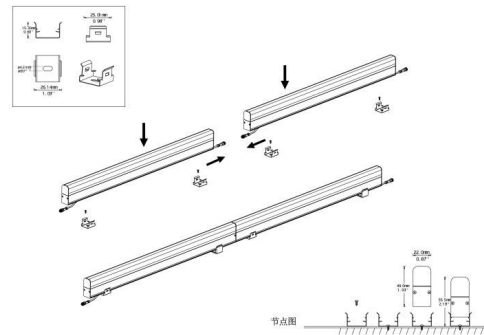

Installation Method 1



Installation Accessories

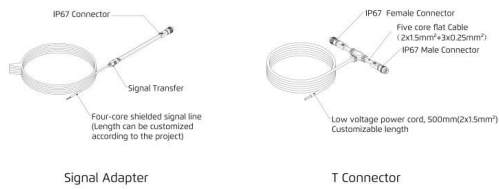

Installation Method 2

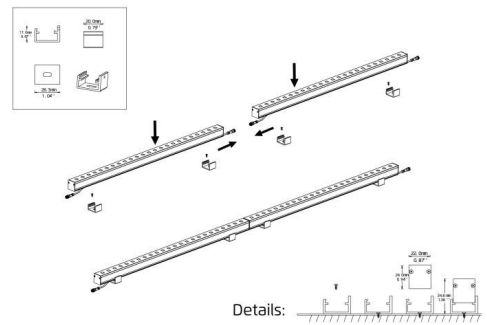

Installation Method 3

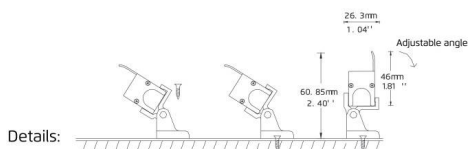
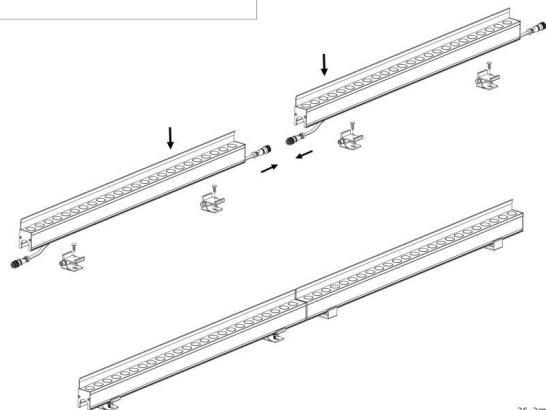
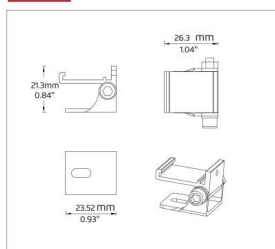

Details:

Control System Diagram

