



### STARO-W

Applique murale Lavov de la gamme STARO-W, d'une puissance de 10 W et d'un angle de faisceau de 15°. Finition noire.





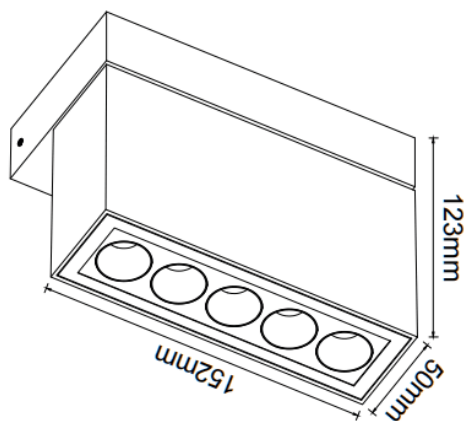

Dimensions : 151 x 123 x 73 mm. Flux lumineux total : 1 080 lm, efficacité lumineuse : 90 lm/W. Température de couleur : 3 000 K. Interrupteur marche/arrêt. Boîtier en aluminium moulé sous pression avec façade en verre trempé. Indice de protection : IP65, IK06.

| Dimensions              |              |
|-------------------------|--------------|
| Product dimensions (mm) | 151X123X73mm |

| Dessin technique |  |
|------------------|--|
|------------------|--|



|                 |  |
|-----------------|--|
| Code article    | 86.OW24.1311.02  |
| Type de produit |  |
| Catégorie       | Appliques murales  |
| Famille         | STARO-W  |
| Pictograms      |     <br>  |

| Produit                       |               |
|-------------------------------|---------------|
| Puissance système (W)         | 10            |
| Flux lumineux utile (lm)      | 1080          |
| Efficacité lumineuse (lm/W)   | 90            |
| Angle de faisceau             | 15            |
| Durée de vie                  | 50000h L80B10 |
| IP                            | IP65          |
| Finition                      | Noir          |
| Driver intégré                | oui           |
| Équipement                    | ON-OFF        |
| Source lumineuse              | LED           |
| Type de LED                   | SMD           |
| Température de couleur (K)    | 3000          |
| Uniformité chromatique (SDCM) | SDCM3         |
| CRI                           | 90            |
| IK                            | IK06          |