



STARO-W

Applique murale Lavov de la gamme STARO-W, d'une puissance de 10 W et d'un angle de diffusion de 24°. Finition noire.





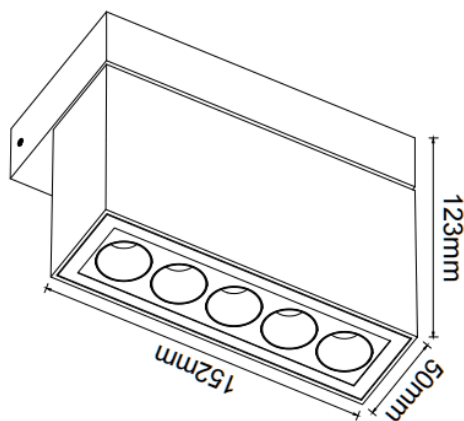

Dimensions : 151 x 123 x 73 mm. Flux lumineux total : 1 080 lm, efficacité lumineuse : 90 lm/W. Température de couleur : 3 000 K. Interrupteur marche/arrêt. Boîtier en aluminium moulé sous pression avec façade en verre trempé. Indice de protection : IP65, IK06.

Dimensions	
Product dimensions (mm)	151X123X73mm

Dessin technique



Distribution photométrique

Code article	86.OW24.1321.02
Type de produit	
Catégorie	Appliques murales
Famille	STARO-W
Pictograms	      

Produit	
Puissance système (W)	10
Flux lumineux utile (lm)	1080
Efficacité lumineuse (lm/W)	90
Angle de faisceau	24
Durée de vie	50000h L80B10
IP	IP65
Finition	Noir
Driver intégré	oui
Équipement	ON-OFF
Source lumineuse	LED
Type de LED	SMD
Température de couleur (K)	3000
Uniformité chromatique (SDCM)	SDCM3
CRI	90
IK	IK06

