







Packing List		
	Base plate templates	1PC
	Screw fixing plate	1PC
	Screw M5x16	5PCS
	Screw M8	3PCS
	Nut M8	3PCS



0.5m

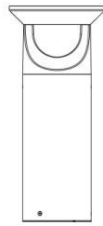

0.9m



**Physical Dimensions(mm/inch)**

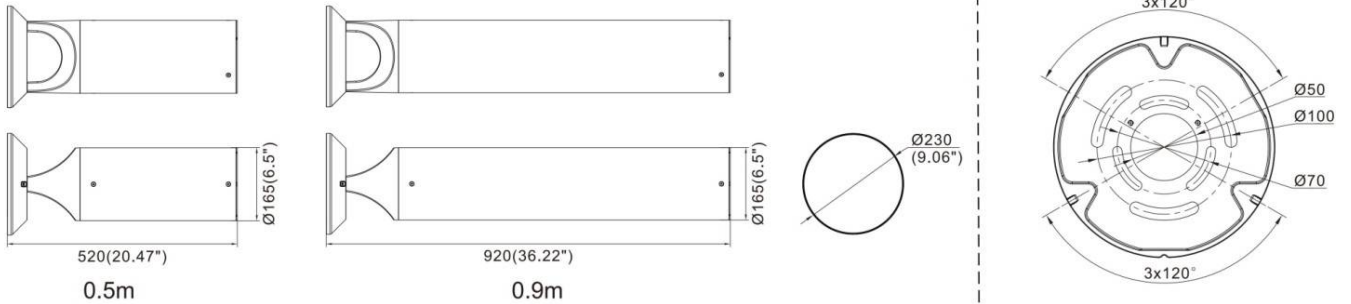

**Installation**

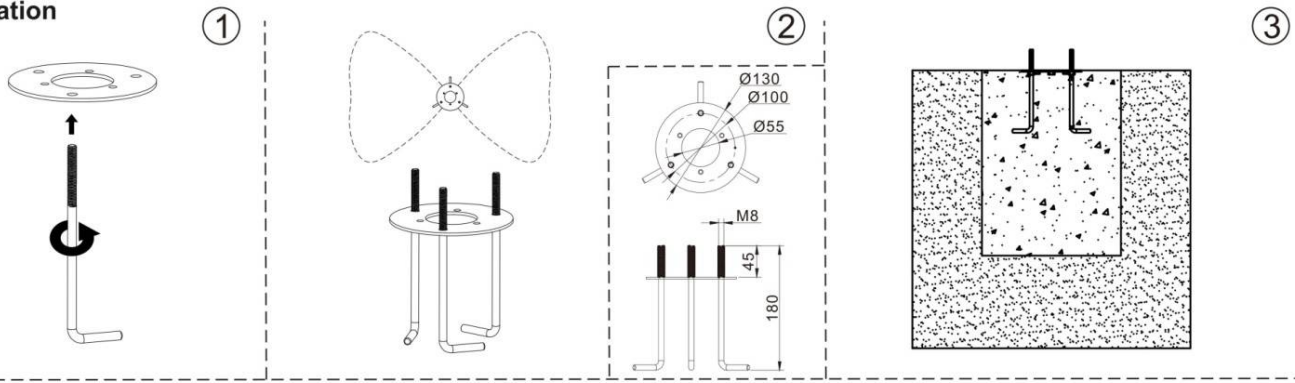

**Suggested cement column size:**

