







Packing List		
	Base plate templates	1PC
	Screw fixing plate	1PC
	Screw M5x16	5PCS
	Screw M8	3PCS
	Nut M8	3PCS



0.5m

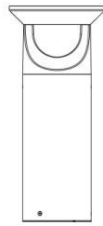

0.9m



Physical Dimensions(mm/inch)

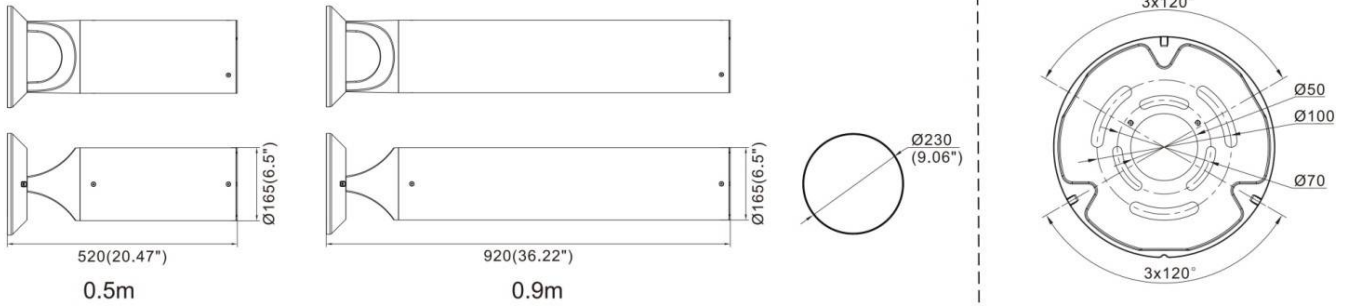

Installation

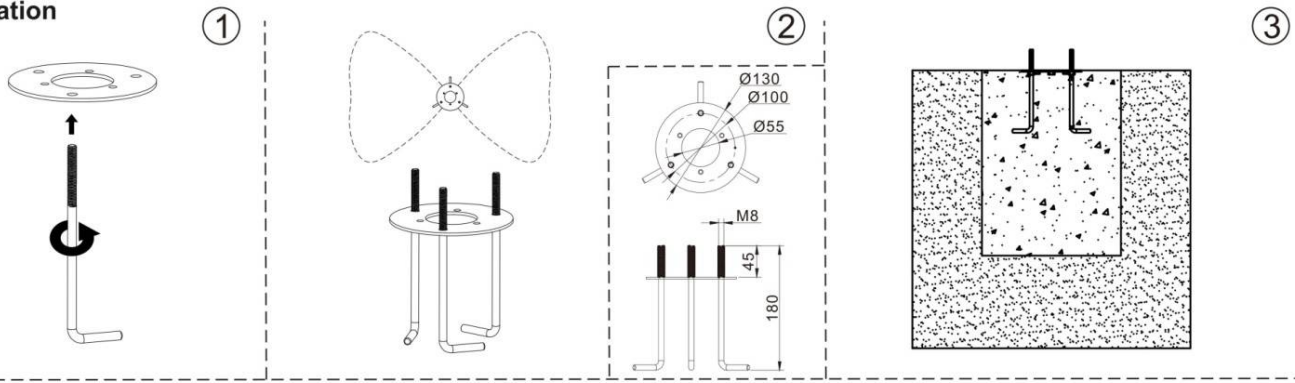

Suggested cement column size:

