**EXTÉRIEURS / ÉCLAIRAGE PUBLIC À
ÉNERGIE SOLAIRE / STELLA HYBRID /
STELLA HYBRID**

Code article 86.SO21.3410.03

LAVOV
L I G H T I N G



STELLA HYBRID

Code article 86.S021.3410.03

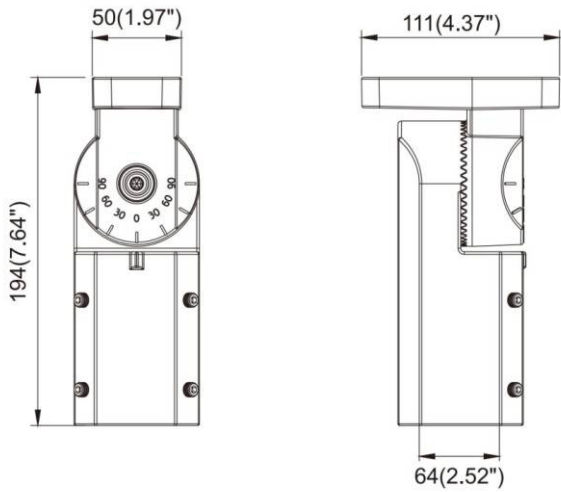

1. ✖

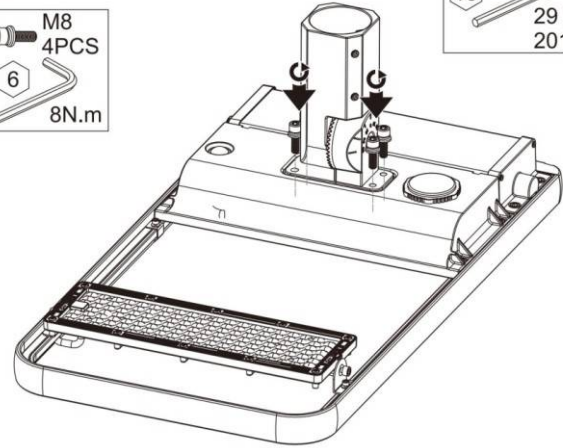
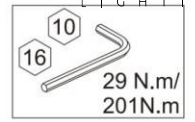

2. ✖

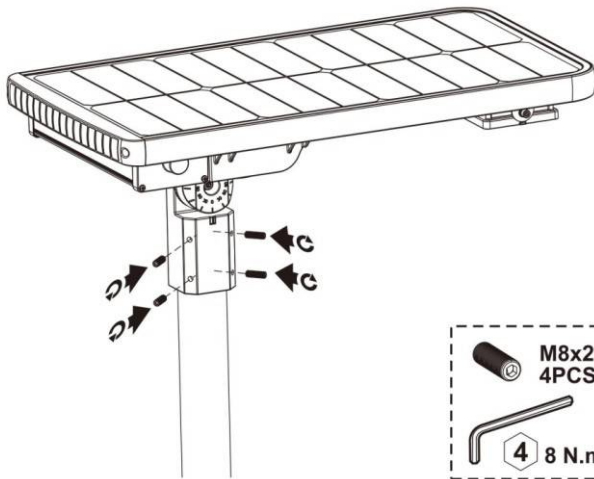

3. ✖

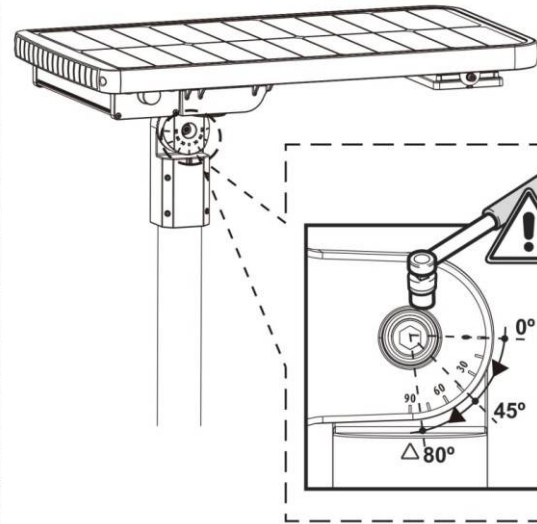

30W-60W

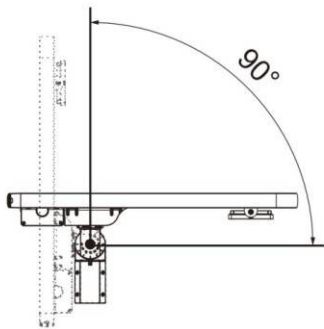

80W-100W

